











-  TYPE III BARRICADE
-  TYPE II BARRICADE
-  TYPE I BARRICADES

-  WARNING SIGNS
-  DETOUR SIGNS
-  DETOUR ROUTING
-  REGULATORY SIGNS

-  DELINEATORS
-  SIGN LOCATION SYMBOL
-  WORK ZONE

 SIDEWALK CLOSED
MUST BE USED
WHENEVER A CITY
SIDEWALK IS TO BE
CLOSED

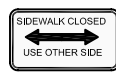
TRAFFIC CONTROL MUST CONFORM TO THE MANUAL ON UNIFORM TRAFFIC CONTROL DEVICES (MUTCO)

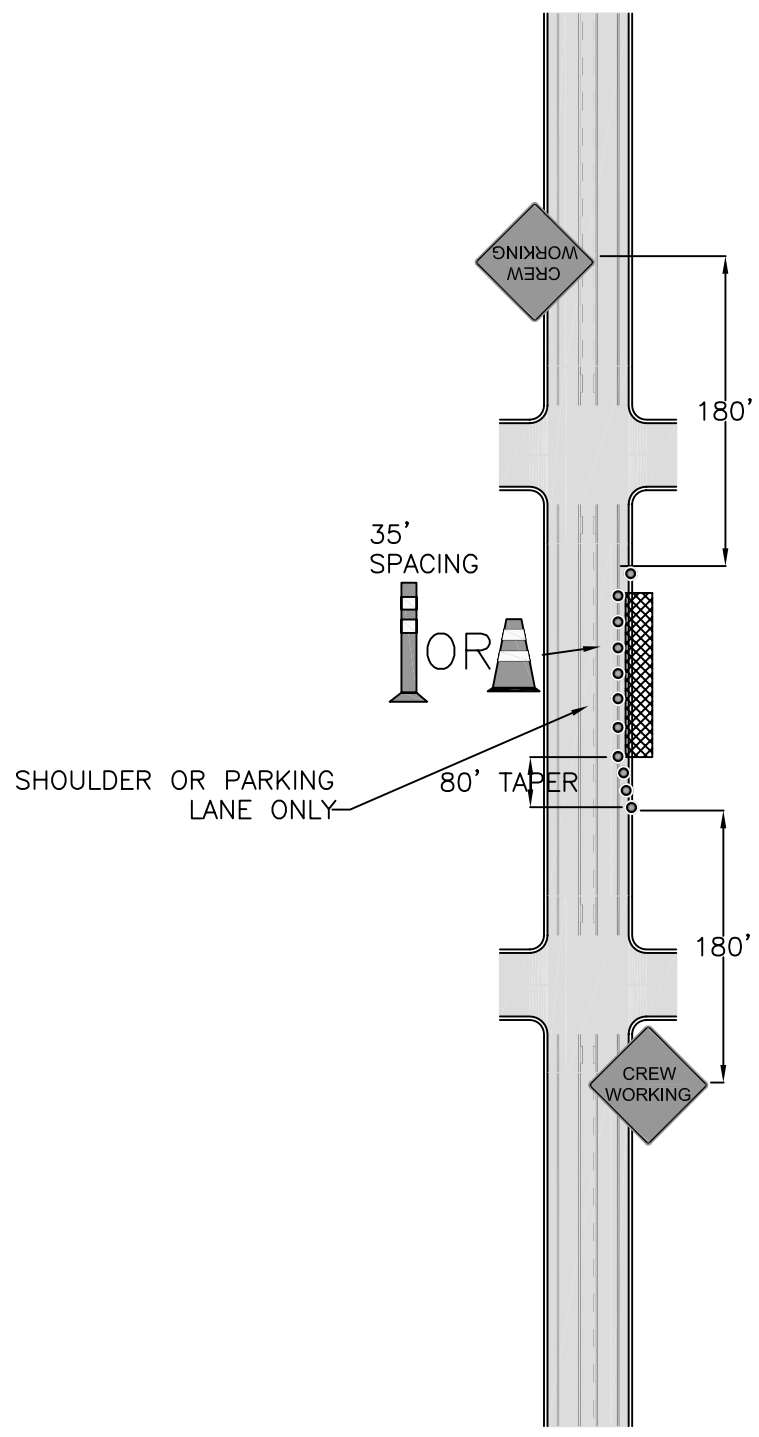

Digital Standard Drawings and other maps are available on the City website: http://www.ci.missoula.mt.us/publicworks/gis_maps.htm



TYPICAL TRAFFIC CONTROL PLAN
STREET CLASSIFICATION:
 3 LANE COLLECTOR
 SHOULDER WORK / CURB SW

Revision Date:
03/2004
TC - 301